

Service Network:

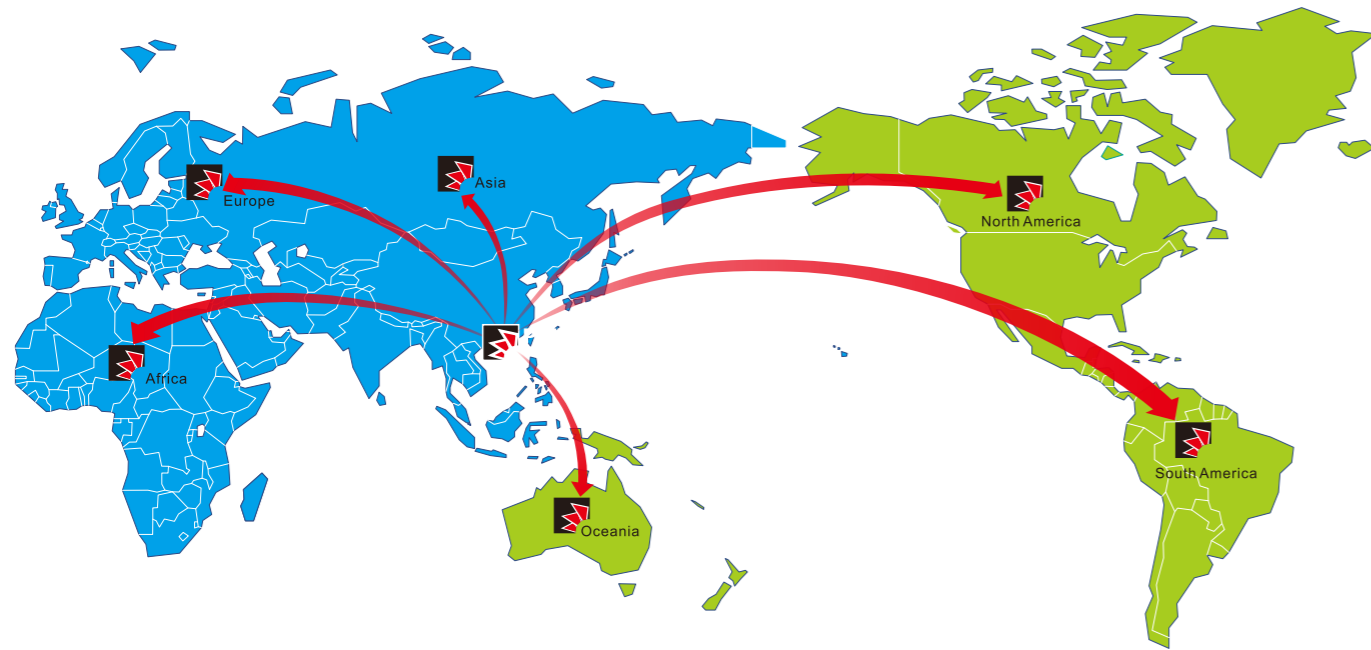

201809ED4.0



# PI500 series

## High-performance standard vector control inverter

Powtran technology

A manufacturer of motor control intelligent products and devices based on motor design.

Contact

**Dalian Powtran Technology Co., Ltd.**

Address: No. 11 Renxian Street, Qixianling,  
Hitech Industrial Zone, Dalian, China (116023)  
Tel: 0411-84820088 84821133  
Fax: 0411-84821978 84821878  
Email: info@powtran.com  
Website: www.powtran.com

**Dalian. Powtran Technology coLtd. Shenzhen Branch.**

Address: No. 75 Baomin 2nd Road, Xixiang Town,  
Baoan District, Shenzhen, China (510101)  
Tel: 0086755-29630738  
Fax: 0086755-29666485  
Email: info@powtran.com  
Website: www.powtran.com



Hotline: 086-755-29630738

Content changes due to continuous upgrade of our products are subject to change without notice. Copyright © Dalian Powtran Technology Co., Ltd. 



[www.powtran.com](http://www.powtran.com)

## Contents

Contents.....	01
Product Overview.....	02
About Powtran.....	03
Product Performance.....	04-11
Nameplate Instruction.....	12
Technical Features.....	13-14
Standard Specification .....	15-16
Keypad Instruction.....	17
Installation Instruction.....	18
Main Circuit Terminal .....	19
Optional Parts.....	20
Applications.....	21-22

## Product Overview

PI500 series high-performance vector control inverter is based on the company's many years of design, production, sales experience, suitable for all kinds of industrial machinery, fan & water pump drive control and heavy industry such as medium frequency grinding. Products in duct design, hardware configuration, software functions, installation design has greatly improved the customer ease of use and environmental adaptability, function optimization, application is more flexible, more stable performance, greatly improve the product reliability.





### Company Introduction

Powtran Technology as a national high-tech enterprise, set up Wuxi, Guangzhou and more than 30 offices with the center of Shenzhen and Dalian cities and established a worldwide network of R & D, production, logistics and service. Composing the advanced technology from Japan Toshiba and Taiwan brand, Powtran provides a series of energy saving and automatic & drive control products. such as frequency inverters(including special power supply), soft starters, AC servo drive system, energy saver, vehicle motor drive system. Powtran products are verified by international authoritative organizations and now export to more than 100 countries.

### Company History

- 2016 : Won the "2015 ~ 2016 annual inverter innovation award"; as the vice chairman of the China Electrical Equipment Industry Association -inverter branch for three consecutive years , and won the advanced member during 2012-2016
- 2015 : PI500 series of high-performance vector inverter was launched; won the award "the most influential brand in three decades";
- 2014: TÜV factory-examining certification company .The standards that Powtran took part in drafting already implemented.
- 2013: PI9000 series new product has passed the EU CE security certification.
- 2012: Continuous 6 years of holding the "low voltage converter top ten domestic brand"
- 2011: Provincial electric drive engineering research center
- 2010: Ministry of science and technology innovation fund for the project
- 2009: National Top-new technical enterprise
- 2008: "The ten major energy conservation projects"
- 2007: The vice chairman of the association of frequency converter enterprise; PS7000 motor environmental protection energy efficient appliances, PI7900 electromagnetic stirring power be inspected by national authoritative organization
- 2006: Bear "Torch Plan" , 863 Plan Projects , PI7000 series inverter passed GB12668 inspection and Provincial scientific and technological achievements appraisal
- 2005: America ABS approve; National authoritative organization verification
- 2004: ISO9001 Quality Certificate

## Technical Features

Rotary self learning	Static self learning
the learning must release load, it is suitable for requiring high control precision	it is suitable for motor can't release load occasions, to avoid can't rotate self-learning after installation

### Precise motor parameter self learning

- Motor parameters can be comprehensive self-study (rotary self learning) or still learning (motor) with the occasion of the load cannot escape, convenient debugging, simple operation, provide higher control accuracy and response speed.

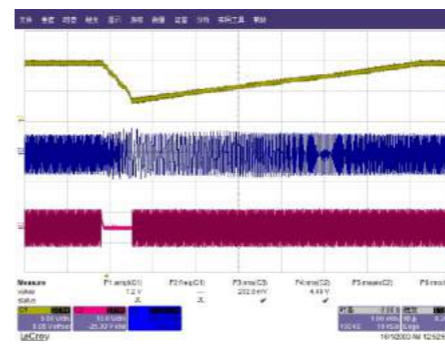

### Instantaneous power off don't stop function

- When grid instantaneous drops or outages, inverter can borrow feedback energy and keep running without stop in effective time, especially suitable for the equipments which needs higher continuity, such as textile production line, chemical fiber.

### reliable design

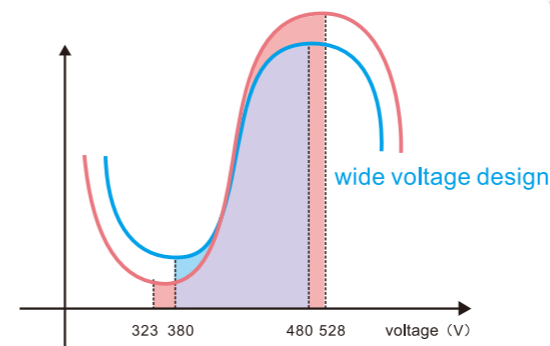

### Meet the international standard of wide voltage input range

- Rated voltage: AC 3phase 380v(-15%) 440v (+10%)
- Allow voltage float range: rated voltage  $\pm 10\%$ .

## Technical Features

### Superior performance in motor drive



#### Advanced motor drive technology

- A variety of motor drive technology: no matter asynchronous motor or synchronous motor, it can implement high-performance current vector control. (eg: normal asynchronous motor Y2 series, Frequency conversion motor with encoder or W/O encode, asynchronous servo motor, permanent magnet synchronous motor etc).

## Technical Features

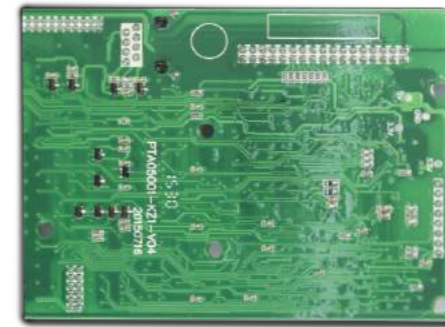

#### Anti-corrosion paint spraying process

- High protection design, use the import anti-corrosion paint, moisture proof, dustproof, oil proof, corrosion resistance, improve the product reliability, 3D painting, no dead Angle

#### Steady speed precision, wide speed range

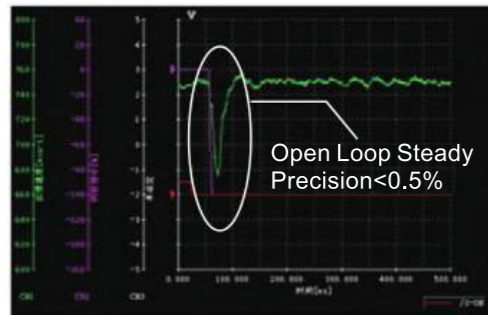

- Open-loop steady speed precision < 0.5%  
High steady speed precision, wide adjust speed range  
Steady speed precision:  $\pm 0.5\%$  (open-loop vector control)  
 $\pm 0.02\%$  (close-loop vector control)  
Adjust speed range: 1:100 (open-loop vector control), 1:1000 (close-loop vector control),  
Torque response: < 40ms (open-loop vector control)
- Heavy load overload capacity :110% rate stable operation (110% continuously operation)  
150% rate load 1Min  
180% rate load 2S.

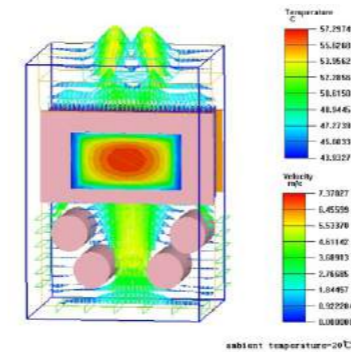

#### Thermal reliability of the machine

- Adopted high precision thermal simulation platform software, ensuring the thermal reliability of the machine.  
PI500 series inverter, all must go through thermal simulation test. Thermal design is scientific simulation tested, good accuracy, quick efficiency, good stability, especially in the condition of limit test, thermal simulation can replace the actual load test simulation, equivalent to more than a layer of scientific thermal test

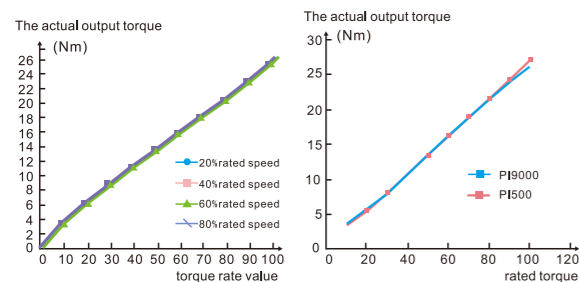

#### Low speed with high torque small torque ripple

- stable Torque output , high torque with low frequency , to realize the stable load of low speed 0.01 Hz, torque mode and speed mode can be convenient to switch
- In close-loop vector control , linear torque linearity deviation within 3%.



#### Machine temperature rise test

- The full series of frequency converter had done the rated load temperature rise test and overload temperature rise test, test results accord with thermal design safety margin, ensure safe and stable operation of the converter

## Technical Features



### EMC Design specifications Improved

- EMC built-in a set of safety capacitance, optional external capacitance group, simple filter, optional filter schaffner can meet C2 international standards
- Using professional grounding pile design, convenient grounding and weaken the electromagnetic interference
- At the scene of the bad to actual application provides EMC filter, common mode rejection, simple filter configuration of a complete set of plan, optimize the environment of EMC electric field devices

Remark: optional filter match CE approve, C2 EMC standard, recommend SCHAFFNER & JIA NLI model.

## Technical Features

### The advanced function of changing the class of machines



### The compact design to improve the speed of realizing machines minimizing

- Collect the minimum frequency inverter with small and light synchronous motor to speed up the machines minimizing;
- Selecting the long life, big wind cooling fans, new generation IGBT module technology ,high efficiency of power, reducing the temperature rise of frequency inverter efficiently, make sure the frequency inverter run steadily.



### Meet a number of certification standards

- Product is suitable for Euro < Technical coordination and standardization methods> requirements.  
EMC directive 2004/108/CE Electromagnetic compatibility directive and LVD directive  
2006/95/EC low voltage directive IEC61000-2-2:2002, IEC61000-4-2:2008, IEC61000-4-3:2008; IEC61800-5-1:2007 etc.
- Meet the ROHS directive

### Over-excitation function

- Fast braking and easy operating without any other periphery braking resistor, etc;
- Inhibit the increasing of DC-bus voltage while deceleration, avoid the frequent err, and fast braking, fast stop.

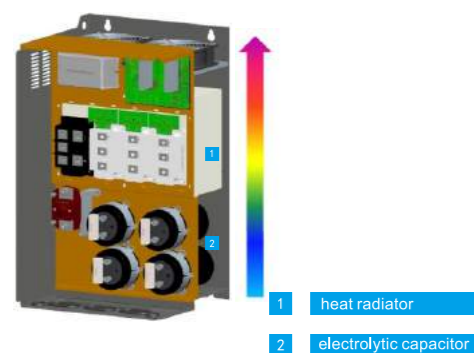
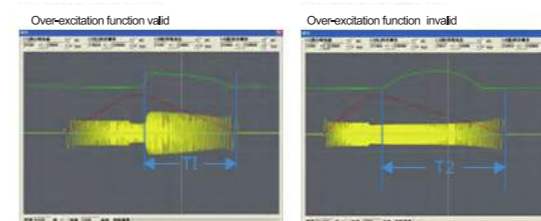

### Independent air duct design

- Independent air duct design, the effect of heat dispelling is better, improve the reliability, which can effectively prevent dust into the converter internal to avoid a short-circuit fault etc
- Select longevity's deadly air cooling fan, effectively reduce the temperature rise of frequency converter, inverter reliable and stable operation

### Various kinds of terminals functions, easier for operation

- There are 51 kinds of multi-function terminals DI ,41 kinds of DO, and 16kinds of AO logical function choice, and meet general purpose frequency inverter normal requirements.
- AI can be used as multi-function terminals'DI' freely;
- AI1~AI3 can be set 4 respectively polylines and3 kinds of curves corresponding relationship separately, AI3 support  $\pm 10\%$ input,easily support PT100
- Good5groups of built-in analog DI and DO function choice, reducing external DI/DO cables,D15 high-speed pulse input terminal and SPB high-speed pulse output terminal support the highest 100khz pulse.A

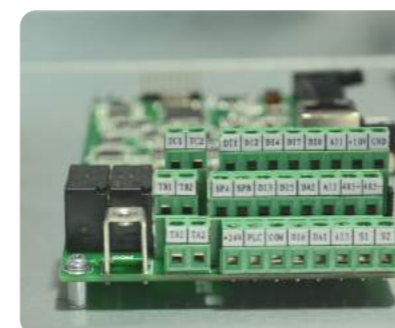

## Technical Features

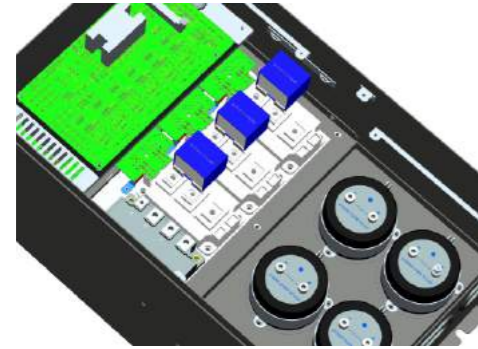

### Long life design

- Adopting the first class manufacturers of rectifier bridge and IGBT, higher configure, greater device selection, and monitor all the temperature rise of key components and pcb board;
- Big temperature rise range, longer life;
- Vibration test to make sure the safety of transportation design;
- Internal logistic management(bar code technology, RF technology);
- Sheet Metal design, adopting Cold-rolled steel and galvanized sheet and powder spraying process on the cover

## Technical Features



### Supporting various kinds of installation ways

- Support rail mounting for 0.75-4kw G3 plastic case machine ;
- Wall-mounted, flange installation is available for 7.5-110kw (flange mounting needs peripheral accessories);
- Wall-mounted, flange installation, floor installation is available for 132-220kw(flange mounting, floor installation needs peripheral accessories);
- Wall-mounted, floor installation is available for 250-400kw (floor installation needs peripheral accessories);
- Floor-mounted is available for 450-630kw

## Great environment friendly function

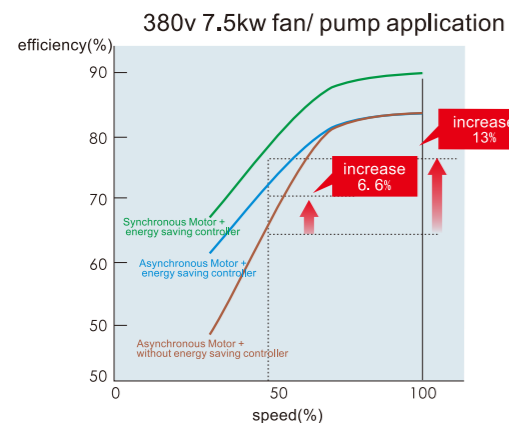

### New generation energy saving running

- Adopt the advanced energy control technology
- With the energy control technology to realize the high efficient running of motor;
- Super energy saving while running with synchronous motor;
- Super energy saving while running with synchronous motor, better than asynchronous motor, realize the super energy saving
- ROHS approved, all components are environment friendly, no harm to people, no pollution..

### PI500 energy saving for example

Before using controller, the fan of air conditioner 7.5kw\*100 sets, price of electricity is RMB 0.7/Kwh, 365days of 1 year.

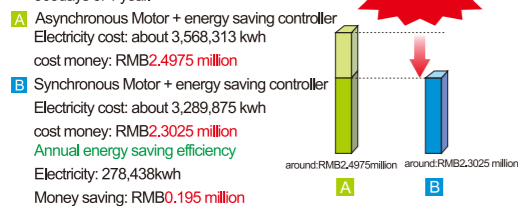

Remark: above example just for reference . real energy saving will be influenced by running condition, load, price of electricity, motor character etc.

### Simple maintenance

- Fan can be disassembled, easy to install, clean and replace.



- 1 fans terminals
- 2 fans fastening screw



## Technical Features

### Built in self-adjusting PID function module

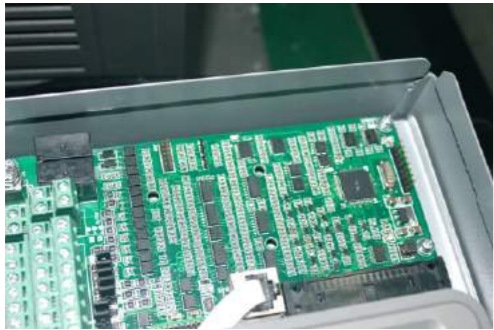

- Built in two groups of PID parameters, it is changeable automatically according to the deviation, DI terminal ,frequency ;
- various given and feedback source, variable and practical type
- PID feedback lost inspection function, it is convenient for user to inspect the fault function;
- Setting factory parameters for special fields to meet the requirements, such as Printing and package, drawing machine, cables etc ,these sites are influenced by changeable diameters, simplify the debugging process ,and easy to maintain the device.

### Easy to use PC software



- Easy to use PC monitoring software, enables tracking and fault location, and with oscilloscope function, it's more convenient for clients to program, debug, real time monitoring is very good for analyzing and management.

### Communication interface application is very flexible

- Support Modbus RTU,CANopen,Profibus-DP bus Protocol;
- Through a dedicated distribution point of the inverter parameters, to realize a good multi-level load distribution, multi-machine control applications droop.

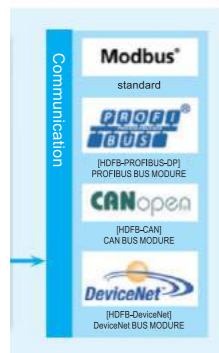

## Nameplate instruction

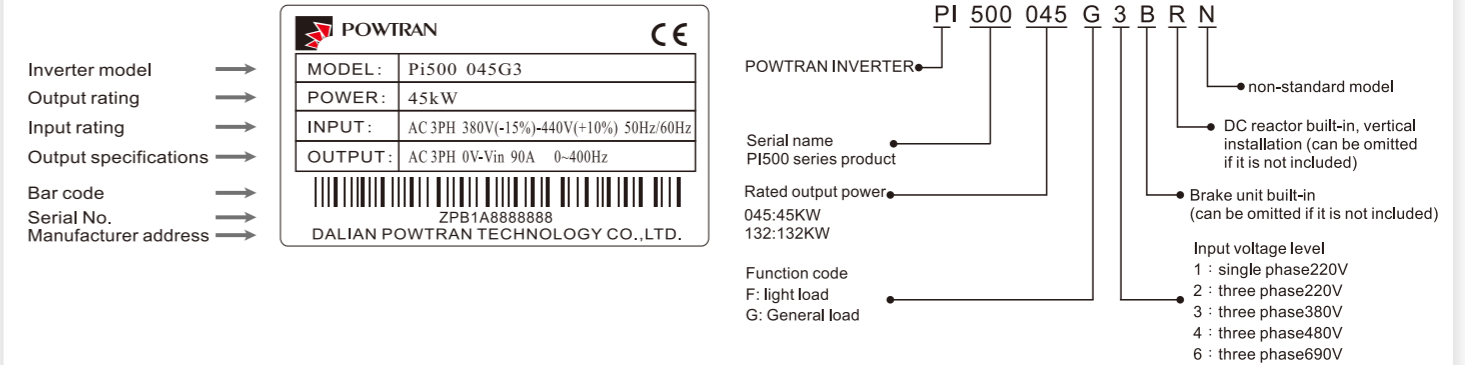

## Technical Specification

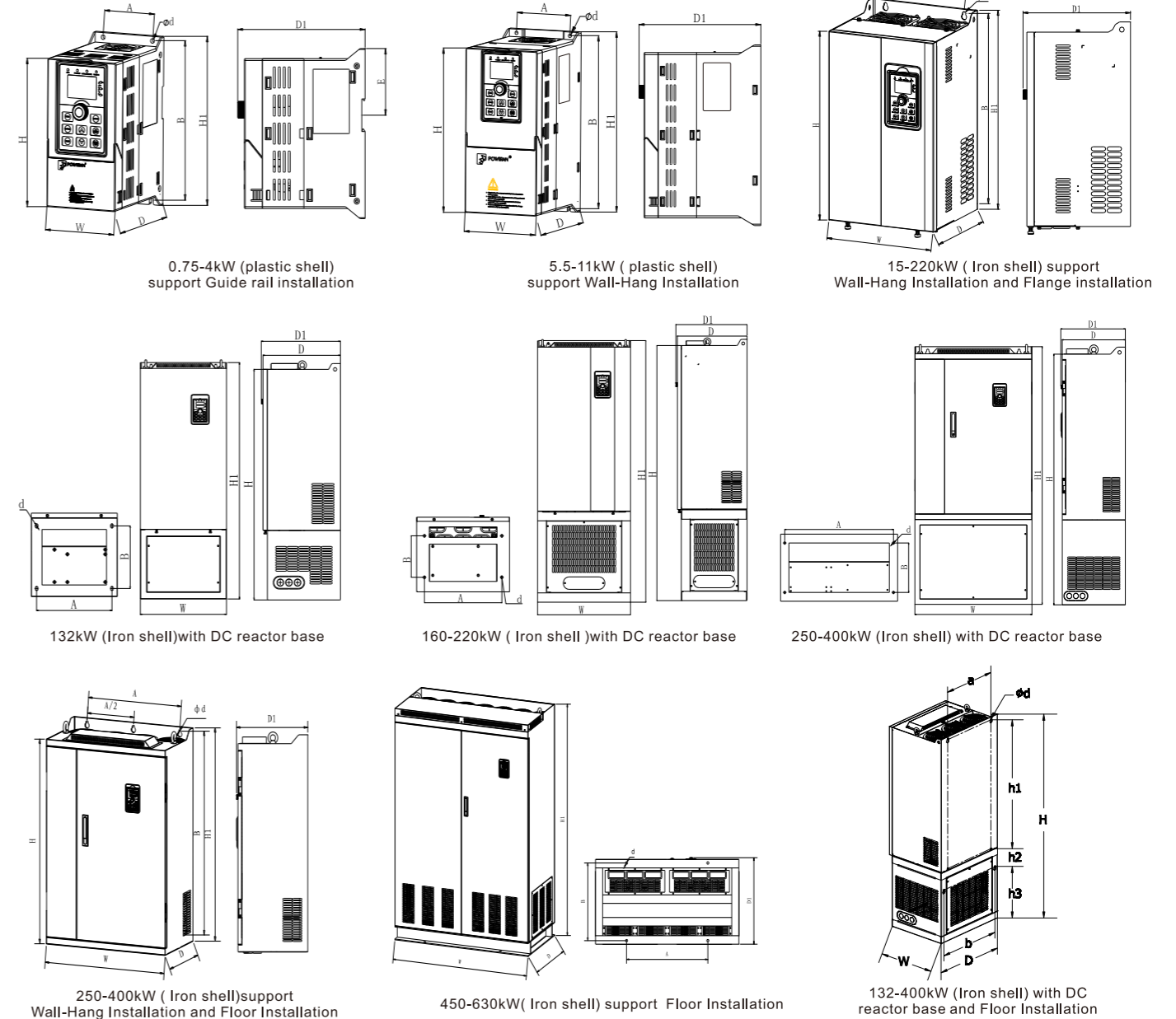

Inverter model	Output power (kW)	Input current (A)	Output current (A)	Dimension(H1xWxD1mm)					Installation (AxB dmm)			N.W (KG)
				H	H1	W	D	D1	A	B	d	
* PI500 0R4G1	0.4	2.5	5.4	163	185	90	146	154	65	174	5	1.6
* PI500 0R7G1	0.75	4	8.2									
* PI500 1R5G1	1.5	7	14									
* PI500 2R2G1	2.2	10	23	163	185	90	166	174	65	174	5	1.8
* PI500 004G1	4	16	35									
* PI500 0R4G2	0.4	2.5	4.1									
* PI500 0R7G2	0.75	4	5.3	163	185	90	146	154	65	174	5	1.6
* PI500 1R5G2	1.5	7	8									
* PI500 2R2G2	2.2	10	11.8									
* PI500 004G2	4	16	18.1	238	260	120	182	190	90	250	5	2.7
* PI500 5R5G2	5.5	25	28									
* PI500 0R7G3	0.75	2.5	4.3									
* PI500 1R5G3	1.5	3.8	5	163	185	90	146	154	65	174	5	1.6
* PI500 2R2G3	2.2	5.1	5.8									
* PI500 004G3	4	9	10.5									
* PI500 5R5G3	5.5	13	14.6	238	260	120	182	190	90	250	5	2.7
* PI500 7R5G3	7.5	17	20.4									
* PI500 011F3	11	17	26									
* PI500 011G3	11	25	26	163	185	90	146	154	65	174	5	1.6
* PI500 0R7G4	0.75	2.5	4.1									
* PI500 1R5G4	1.5	3.7	4.9									
* PI500 2R2G4	2.2	5	5.7	163	185	90	166	174	65	174	5	1.8
* PI500 004G4	4	8	9.4									
* PI500 5R5G4	5.5	11	12.5									
* PI500 7R5G4	7.5	15	18.3	238	260	120	182	190	90	250	5	2.7
* PI500 011F4	11	22	23.1									
* PI500 011G4	11	22	23.1									
PI500 5R5G1	5.5	50	25	280	300	190	190	198	140	285	6	7.2
PI500 7R5G2	7.5	37.1	32	280	300	190	190	198	140	285	6	7.2
PI500 011G2	11	49.8	45	330	350	210	190	198	150	335	6	9.5
PI500 015G2	15	65.4	60	380	400	240	215	223	180	385	7	13
PI500 018G2	18.5	81.6	75									
PI500 022G2	22	97.7	90									
PI500 030G2	30	122.1	110	500	520	300	275	283	220	500	10	42
PI500 037G2	37	157.4	152									
PI500 045G2	45	185.3	176									
PI500 055G2	55	214	210	550	575	355	320	328	250	555	10	58
PI500 075G2	75	307	307									
PI500 093G2	93	383	380									
PI500 110G2	110	428	426	790	820	480	390	398	370	800	11	108
PI500 132G2	132	467	465									
PI500 160G2	160	522	520									
PI500 015F3	15	35	32	280	300	190	190	198	140	285	6	7.2
PI500 015G3/018F3	15/18.5	35/38.5	32/37									
PI500 018G3/022F3	18.5/22	38.5/46.5	37/45									
PI500 022G3/030F3	22/30	46.5/62	45/60	330	350	210	190	198	150	335	6	9.5
PI500 033G3/037F3	30/37	62/76	60/75									
PI500 037G3/045F3	37/45	76/91	75/90									
PI500 045G3N	45	91	90	380	400	240	215	223	180	385	7	13
PI500 045G3/055F3	45/55	91/112	90/110									
PI500 055G3	55	112	110									
PI500 075F3	75	157	150	500	520	300	275	283	220	500	10	42
PI500 075G3	75	157	150									
PI500 093F3	93	180	176									
PI500 093G3/110F3	93/110	180/214	176/210	550	575	355	320	328	250	555	10	58
PI500 110G3/132F3	110/132	214/256	210/253									

Inverter model	Output power (kW)	Input current (A)	Output current (A)	Dimension(H1xWxD1mm)					Installation (AxB dmm)			N.W (KG)
				H	W	D	D1	A	B	d		
PI500 132G3/160F3	132/160	256/307	253/304	695	720	400	360	368	300	700	10	73
PI500 160G3/187F3	160/187	307/345	304/340	790	820	480	390	398	370	800	11	108
PI500 187G3/200F3	187/200	345/385	340/380									
PI500 200G3/220F3	200/220	385/430	380/426									
PI500 220G3	220	430	426	940	980	560	410	418	415	945	13	153
PI500 250F3	250	468	465									
PI500 250G3/280F3	250/280	468/525	465/520									
PI500 280G3	280	525	520	940	980	705	410	418	550	945	13	190
PI500 315F3	315	590	585									
PI500 315G3/355F3	315/355	590/665	585/650									
PI500 355G3/400F3	355/400	665/785	650/725	/	1700	1200	600	612	680	550	17	/
PI500 400G3	400	785	725									
PI500 450F3R	450	883	820									
PI500 450G3R/500F3R	450/500	883/920	820/860	/	1700	1200	600	612	680	550	17	/
PI500 500G3R/560F3R	500/560	920/1010	860/950									
PI500 560G3R/630F3R	560/630	1010/1160	950/1100									
PI500 630G3R/700F3R	630/700	1160/1310	1100/1250	280	300	190	190	198	140	285	6	7.2
PI500 015F4	15	29.8	27									
PI500 015G4/018F4	15/18.5	29.8/35.7	27/34									
PI500 018G4/022F4	18.5/22	35.7/41.7	34/40	330	350	210	190	198	150	335	6	9.5
PI500 022G4/030F4	22/30	41.7/57.4	40/55									
PI500 030G4/037F4	30/37	57.4/66.5	55/65									
PI500 037G4/045F4	37/45	66.5/81.7	65/80	380	400	240	215	223	180	385	7	13
PI500 045G4N	45	81.7	80									
PI500 045G4/055F4	45/55	81.7/101.9	80/100									
PI500 055G4	55	101.9	100	500	520	300	275	283	220	500	10	42
PI500 075F4	75	137.4	130									
PI500 075G4	75	137.4	130									
PI500 093F4	93	151.8	147	550	575	355	320	328	250	555	10	58
PI500 093G4/110F4	93/110	151.8/185.3	147/180									
PI500 110G4/132F4	110/132	185.3/220.7	180/216									
PI500 132G4/160F4	132/160	220.7/264.2	216/259	695	720	400	360	368	300	700	10	72.5
PI500 160G4/187F4	160/187	264.2/309.4	259/300	790	820	480	390	398	370	800	11	108
PI500 187G4/200F4	187/200	309.4/334.4	300/328									
PI500 200G4/220F4	200/220	334.4/363.9	328/358									
PI500 220G4	220	363.9	358	940	980	560	410	418	415	945	13	153
PI500 250F4	250	407.9	400									
PI500 250G4/280F4	250/280	407.9/457.4	400/449									
PI500 280G4	280	457.4	449	940	980	705	410	418	550	945	13	190
PI500 315F4	315	533.2	516									
PI500 315G4/355F4	315/355	533.2/623.3	516/570									
PI500 355G4/400F4	355/400	623.3/706.9	570/650	/	1700	1200	600	612	680	550	17	/
PI500 400G4	400	706.9	650									
PI500 011G6/015F6	11/15	15/20	12/15									
PI500 015G6/018F6	15/18.5	20/30	15/20	500	520	300	275	283	220	500	10	42
PI500 018G6/022F6	18.5/22	30/35	20/24									
PI500 022G6/030F6	22/30	35/45	24/33									
PI500 030G6/037F6	30/37	45/55	33/41	790	820	480	390	398	370	800	11	108
PI500 037G6/045F6	37/45	55/65	41/50									
PI500 045G6/055F6	45/55	65/70	50/62									
PI500 055G6/075F6	55/75	70/90	62/85	550	575	355	320	328	250	555	10	58
PI500 075G6/093F6	75/93	90/105	85/102									
PI500 093G6/110F6	93/110	105/130	102/125									
PI500 110G6/132F6	110/132	130/170	125/150	/	1700	1200	600	612	680	550	17	/
PI500 132G6/160F6	132/160	170/200	150/175									
PI500 160G6/187F6	160/187	200/210	175/198									
PI500 187G6/200F6	187/200	210/235	198/215	940	980	705	410	418	550	945	13	190
PI500 200G6/220F6	200/220	235/247	215/245									
PI500 220G6/250F6	220/250	247/265	245/260									
PI500 250G6/280F6	250/280	265/305	260/299	/	1700	1200	600	612	680	550	17	/
PI500 280G6/315F6	280/315	305/350	299/330									
PI500 315G6/355F6	315/355	350/382	330/374									
PI500 355G6/400F6	355/400	382/435	374/410	550	575	355	320	328	250	555	10	58
PI500 400G6/450F6	400/450	435/490	410/465									





Inverter model	Output power (kW)	Input current (A)	Output current (A)	Dimension(H1xWxD1mm)						Installation (AxB dmm)			N.W (KG)
				H	H1	W	D	D1	A	B	d		
PI500 132G3R/160F3R	132/160	256/307	253/304	995	1020	400	360	368	350	270	13*18	115	
PI500 160G3R/187F3R	160/187	307/345	304/340	1230	1260	480	390	398	400	200	13	153	
PI500 187G3R/200F3R	187/200	345/385	340/380										
PI500 200G3R/220F3R	200/220	385/430	380/426										
PI500 220G3R	220	430	426										
PI500 250F3R	250	468	465	1419	1460	560	410	418	500	310	13	205	
PI500 250G3R/280F3R	250/280	468/525	465/520										
PI500 280G3R	280	525	520										
PI500 315F3R	315	590	585	1419	1460	705	410	418	620	240	13	249.4	
PI500 315G3R/355F3R	315/355	590/665	585/650										
PI500 355G3R/400F3R	355/400	665/785	650/725										
PI500 400G3R	400	785	725										
PI500 132G4R/160F4R	132/160	220.7/264.2	216/259	995	1020	400	360	368	350	270	13*18	115	
PI500 160G4R/187F4R	160/187	264.2/309.4	259/300	1230	1260	480	390	398	400	200	13	153	
PI500 187G4R/200F4R	187/200	309.4/334.4	300/328										
PI500 200G4R/220F4R	200/220	334.4/363.9	328/358										
PI500 220G4R	220	363.9	358										
PI500 250F4R	250	407.9	400	1419	1460	560	410	418	500	310	13	205	
PI500 250G4R/280F4R	250/280	407.9/457.4	400/449										
PI500 280G4R	280	457.4	449										
PI500 315F4R	315	533.2	516	1419	1460	705	410	418	620	240	13	249.4	
PI500 315G4R/355F4R	315/355	533.2/623.3	516/570										
PI500 355G4R/400F4R	355/400	623.3/706.9	570/650										
PI500 400G4R	400	706.9	650										

Inverter model	Output power (kW)	Input current (A)	Output current (A)	Dimension(mm)			Installation (dmm)								N.W (KG)
				H	W	D	h1	h2	h3	a	b	d	d1	e	
PI500 132G3R/160F3R	132/160	256/307	253/304	400	1020	360	702	89	218	300	370	10	18	11	/
PI500 160G3R/187F3R	160/187	307/345	304/340	480	1260	390	801	119	325	370	435	11	20	12	/
PI500 187G3R/200F3R	187/200	345/385	340/380												
PI500 200G3R/220F3R	200/220	385/430	380/426												
PI500 220G3R	220	430	426												
PI500 250F3R	250	468	465	560	1460	410	947	164	330	416	530	13	24	15	/
PI500 250G3R/280F3R	250/280	468/525	465/520												
PI500 280G3R	280	525	520												
PI500 315F3R	315	590	585	705	1460	410	947	94	400	550	675	13	24	15	/
PI500 315G3R/355F3R	315/355	590/665	585/650												
PI500 355G3R/400F3R	355/400	665/785	650/725												
PI500 400G3R	400	785	725												
PI500 132G4R/160F4R	132/160	220.7/264.2	216/259	400	1020	360	702	89	218	300	370	10	18	11	/
PI500 160G4R/187F4R	160/187	264.2/309.4	259/300	480	1260	390	801	119	325	370	435	11	20	12	/
PI500 187G4R/200F4R	187/200	309.4/334.4	300/328												
PI500 200G4R/220F4R	200/220	334.4/363.9	328/358												
PI500 220G4R	220	363.9	358												
PI500 250F4R	250	407.9	400	560	1460	410	947	164	330	416	530	13	24	15	/
PI500 250G4R/280F4R	250/280	407.9/457.4	400/449												
PI500 280G4R	280	457.4	449												
PI500 315F4R	315	533.2	516	705	1460	410	947	94	400	550	675	13	24	15	/
PI500 315G4R/355F4R	315/355	533.2/623.3	516/570												
PI500 355G4R/400F4R	355/400	623.3/706.9	570/650												
PI500 400G4R	400	706.9	650												

## Assembly drawing

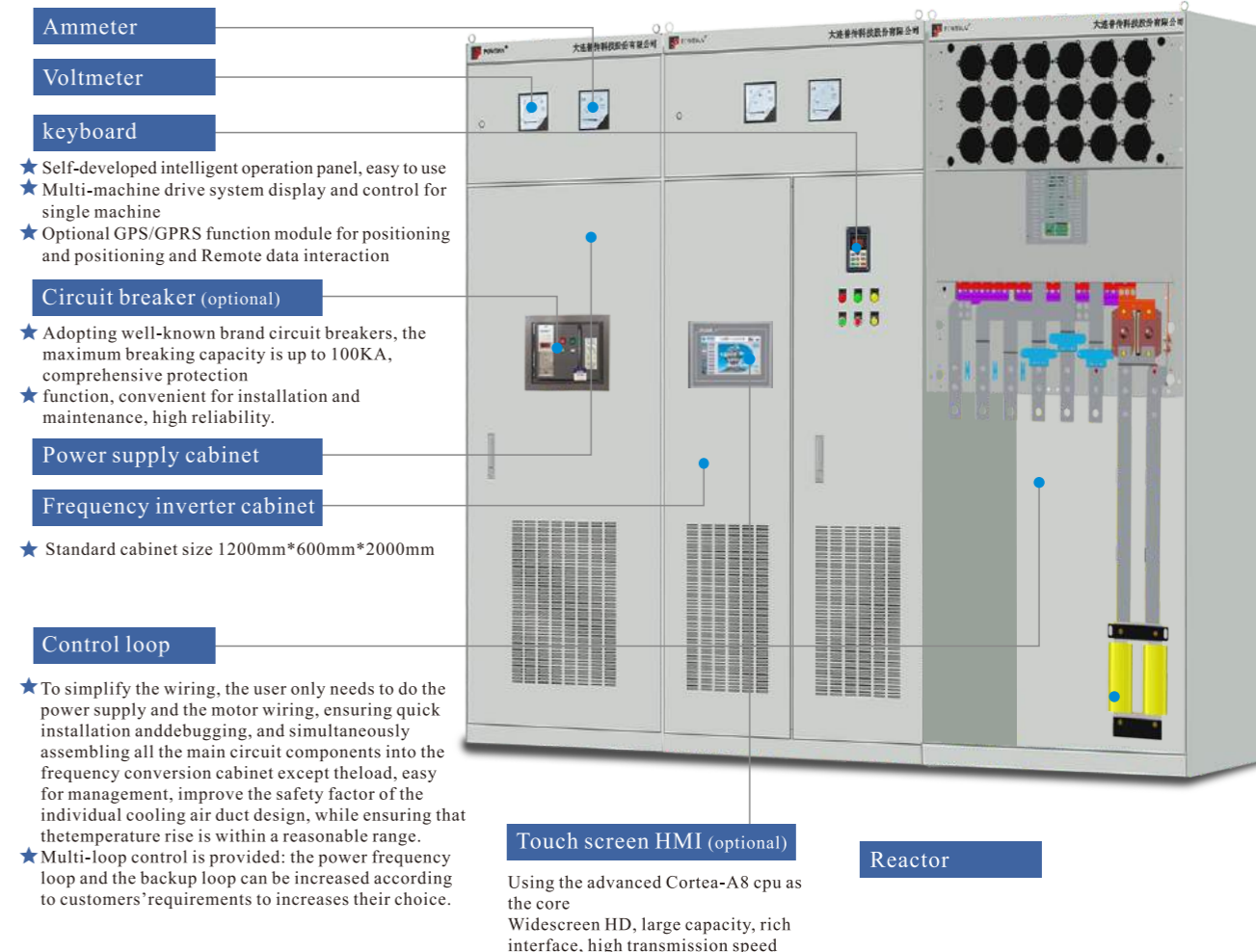









## Technical Specification

Model	Rated Current	Machine configuration	Rack configuration	Cabinet size
PS9550 018G3	37A	PI500 018-022G3	Precision cabinet	450*350*1300mm
PS9550 022G3	45A			
PS9550 030G3	60A			
PS9550 037G3	75A	PI500 030-037G3		600*400*1600mm
PS9550 045G3	90A			
PS9550 055G3	110A			
PS9550 075G3	150A	PI500 045-075G3	800*450*1800mm	
PS9550 093G3	176A			
PS9550 110G3	210A			
PS9550 132G3	253A	PI500 132-187G3	GGD Welding cabinet	800*600*2000mm
PS9550 160G3	304A			
PS9550 187G3	340A			
PS9550 200G3	380A			
PS9550 220G3	426A			
PS9550 250G3	465A			
PS9550 280G3	520A	PI500 200-280G3		1000*600*2000mm
PS9550 315G3	585A			
PS9550 355G3	650A			
PS9550 400G3	725A	PI500 315-450G3		1200*600*2000mm
PS9550 450G3	820A			
PS9530 500G3	860A			
PS9530 560G3	950A	PI9000 500-800F3	1200*600*2000mm	
PS9530 630G3	1100A			
PS9530 710G3	1250A			
PS9530 800F3	1430A			

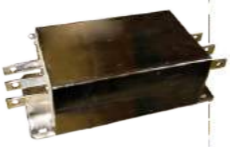
Note: PS series cabinet structure has GGD, welding cabinet. other divisions have been welding cabinets required to be made according to our standards.

## The selection of peripheral accessories

Name	Brand	Quantity	Picture
Inlet and outlet terminals	*	4+3	
Breaker	CHINT/Tianshui	1	
AC contactor	CHINT/Tianshui	1	
Reactor	Sudun	1	
Input filter	Sudun	1	
Output filter	Sudun	1	
Braking resistor	POWTRAN	1	
Ammeter	Dajiang	1	
Voltmeter	Dajiang	1	
Current Transformer	Dajiang	1	

## Application field



### Field application case

#### (1) A tire rubber group company

- 1、 Load type: twin-screw tablet press Motor  
Rated frequency: 50Hz; Power: 250kW;  
Rated current: 466A; Rated speed: 980 r/min;
- 2、 On-site process conditions: the twin-screw tablet driven by the inverter after the rubber particles are softened by heating and softening. The rubber enters the model, and the rubber formed by the abrasive is pressed to form a tire film;
- 3、 grid status: grid voltage inverter does not work before the voltage is 385V, the inverter works. Pressed at 380V, the load does not pull down the grid voltage;
- 4、 Equipment operation mode: After the inverter is started, the frequency is adjusted by the touch screen to 50Hz fixed frequency, frequency conversion. The acceleration time is 40S;
- 5、 equipment running time: the inverter works 24 hours a day.



#### (2) An oilfield power group

- 1、 Load type: water injection pump Motor  
Rated frequency: 50Hz; Power: 250kW;  
Rated current: 457.0A; Rated speed: 990r/min;
- 2、 Description of on-site working conditions: The frequency converter is applied to the piston injection pump, and the grid voltage is about 390V.
- 3、 sets of 250KW water injection pumps, 2 with 1 spare, and rotate once every half a month.



#### (3) A certain city Heavy load Machinery Co., Ltd.

- The project is a newly developed tourism project that adds pneumatic amusement equipment;
- 1, Load type: transfer. Rated motor frequency: 50Hz; Power: 630kW; Rated current: 1093A; Rated speed: 960 r/min
  2. Description of on-site working conditions: After the inverter is on site, it is responsible for guiding customer installation, guiding wiring and electrical debugging. During the last two days of the first tourism conference of City, Party A hopes that the manufacturer's technical personnel can ensure that the field equipment can operate normally on site;
  3. Operation result: After the on-site engineer debugging is completed, the general-purpose inverter runs stably. The flight distance of the personnel is about 3 meters from the ground. It is affirmed by the leaders of the provincial party committee and the municipal party committee. The boss who invested in the project is satisfied with the general-purpose inverter. Leaders and neighboring city leaders visited and experienced on-site, successfully completed flight tests, and the professional flight height reached 4-5 meters.



## Standard specification

Item	Function	Specification	
Power	Rated voltage level	AC 3PH 480V(-10%)~480V(+10%) AC 3PH 380V(-15%)~440V(+10%) AC 1PH 220V(-15%)~240V(+10%) AC 3PH 220V(-15%)~240V(+10%)	
	Input frequency	50Hz/60Hz	
	Allowable fluctuation	Voltage continued volatility $\pm 10\%$ input frequency volatility: $\pm 5\%$ Voltage unbalance rate less than 3%      Distortion meet IEC 61800-2 standard	
Control System	Control system	High performance vector control inverter based on DSP	
	Control method	V/F control, vector control W/O PG, vector control W/PG	
	Automatic torque boost function	Realize low frequency (1Hz) and large output torque control under the V/F control mode.	
	Acceleration/deceleration control	Straight or S-curve mode. Four times available and time range is 0.0 to 6500.0s.	
	V/F curve mode	Linear, square root/m-th power, custom V/F curve	
	Over load capability		G type: rated current 150% - 1 minute, rated current 180% - 2 seconds F type: rated current 120% - 1 minute, rated current 150% - 2 seconds
	Maximum frequency	Vector control: 0 to 300Hz    V/F control: 0 to 3200Hz	
	Carrier Frequency	0.5 to 16kHz; automatically adjust carrier frequency according to the load characteristics.	
	Input frequency resolution	Digital setting: 0.01Hz Analog setting: maximum frequency $\times 0.1\%$	
	Start torque	G type: 0.5Hz/150% (vector control W/O PG) F type: 0.5Hz/100% (vector control W/O PG)	
	Speed range	1:100 (vector control W/O PG) 1:1000 (vector control W/ PG)	
	Steady-speed precision	Vector control W/O PG: $\leq \pm 0.5\%$ (rated synchronous speed) Vector control W/ PG: $\leq \pm 0.02\%$ (rated synchronous speed)	
Torque response	$\leq 40\text{ms}$ (vector control W/O PG)		
Torque boost	Automatic torque boost; manual torque boost(0.1% to 30.0%)		
DC braking	DC braking frequency: 0.0Hz to max. frequency, braking time: 0.0 to 36.0 seconds, braking current value: 0.0~100.0s		
Jogging control	Jog Frequency Range: 0.00Hz to max. frequency; Jog Ac/deceleration time: 0.0s~6500.0s		
Multi-speed operation	Achieve up to 16-speed operation through the control terminal		
Built-in PID	Easy to realize closed-loop control system for the process control.		
Automatic voltage regulation(AVR)	Automatically maintain a constant output voltage when the voltage of electricity grid changes		
Torque limit and control	"Excavator" feature - torque is automatically limited during the operation to prevent frequent overcurrent trip; the closed-loop vector mode is used to control torque.		
Personalization function	Self-inspection of peripherals after power-on	After powering on, peripheral equipment will perform safety testing, such as ground, short circuit, etc.	
	Common DC bus function	Multiple inverters can use a common DC bus.	
	Quick current limiting	The current limiting algorithm is used to reduce the inverter overcurrent probability, and improve whole unit anti-interference capability.	
	Timing control	Timing control function: time setting range(0h to 6500m).	

## Standard specification

Item	Function	Specification		
Running	Input signal	Running method	Keyboard/terminal/communication	
		Frequency setting	10 frequency setting available, including adjustable DC 0~10V / -10~+10V, adjustable DC 0~20mA, panel potentiometer	
		Start signal	Rotate forward/reverse	
		Multi-speed	At most 16-speed can be set(run by using the multi-function terminals or program)	
		Emergency stop	Interrupt controller output	
		Wobble run	Process control run	
	Output signal	Fault reset	When the protection function is active, you can automatically or manually reset the fault condition.	
		PID feedback signal	Including DC(0 to 10V), DC(0 to 20mA)	
		Running status	Motor status display, stop, ac/deceleration, constant speed, program running status.	
		Fault output	Contact capacity: normal-closed contact 3A/AC 250V; normal-opened contact 5A/AC 250V; 1A/DC 30V.	
Protection function	Analog output	Two-way analog output, 16 signals can be selected such as frequency, current, voltage and other, output signal range(0 to 10V / 0 to 20mA).		
	Output signal	At most 4-way output, there are 40 signals each way		
	Run function	Limit frequency, jump frequency, frequency compensation, auto-tuning, PID control		
	DC current braking	Built-in PID regulates braking current to ensure sufficient braking torque under no overcurrent condition.		
	Running command channel	Three channels: operation panel, control terminals and serial communication port. They can be switched through a variety of ways.		
	Frequency source	Total 10 frequency sources: digital, analog voltage, analog current, multi-speed and serial port. They can be switched through a variety of ways.		
Display	Input terminals	8 digital input terminals, compatible with active PNP or NPN input mode, one of them can be for high-speed pulse input(0~100Hz square wave); 3 analog output terminals, AI1 and AI2 can choose 0~10V or 0~20mA input, AI3 voltage is -10~+10V input.		
	Output terminals	2 digital output terminals, one of them can be for high-speed pulse output(0 to 100kHz square wave); one relay output terminal; 2 analog output terminals respectively for optional range (0 to 20mA or 0 to 10V), they can be used to set frequency, output frequency, speed and other physical parameters.		
	Inverter protection		Overvoltage protection, undervoltage protection, overcurrent protection, overload protection, overheat protection, overcurrent stall protection, overvoltage stall protection, losing-phase protection (optional), external fault, communication error, PID feedback signal abnormalities, PG failure and short circuit to ground protection.	
		IGBT temperature display	Displays current temperature IGBT	
		Inverter fan control	Can be set	
		Instantaneous power-down restart	Less than 15 milliseconds: continuous operation. More than 15 milliseconds: automatic detection of motor speed, instantaneous power-down restart.	
	Communication	Speed start tracking method	The inverter automatically tracks motor speed after it starts	
		Parameter protection function	Protect inverter parameters by setting administrator Password and decoding	
		LED/OLED display keyboard	Running information	Monitoring objects including : running frequency, set frequency, actual motor current, DC bus voltage, output voltage, actual motor speed, cumulative running time, IGBT temperature, PID reference value, PID feedback value, input terminal status, output terminal status, analog AI1 value, analog AI2 value, current stage of multi-speed, torque set value.
			Error message	At most save 3 error message, and the time, type, voltage, current, frequency and work status can be queried when the failure is occurred.
LED display		Display parameters	Optional, prompts operation content in Chinese/English text.	
Environment	OLED display	Can uploading or downloading the function code information of frequency inverters, do the parameter copy quickly.		
	Parameters copy	Lock part or all of keys, define the function scope of some keys to prevent misuse.		
	Key lock and function selection	The optional completely isolated RS485 communication module can communicate with the host computer.		
	RS485	-10 °C to 40 °C (temperature at 40 °C to 50 °C, please derating for use) -20 °C to 65 °C Does not exceed 90% R.H, no condensation of moisture Below 5.9m/s <sup>2</sup> (= 0.6g) Indoor where no sunlight or corrosive, explosive gas and water vapor, dust, flammable gas, oil mist, water vapor, drip or salt, etc. Below 1000m 2 IP20		
Product standard	Product adopts safety standards.	IEC61800-5-1:2007		
	Product adopts EMC standards.	IEC61800-3:2005		
	Cooling method	Forced air cooling		

## Operating keyboard (button key description)



Sign	Name	Function
	Parameter Setting/ Exit Key	*Enter top menu parameter change status *Exit from function option change *Return to status display menu from sub-menu or function option menu
	Shift Key	*Select circularly parameters under run or stop interface; *Select parameters when modifying the parameters.
	Ascending Key	*UP key setted by parameter F6.18
	Decending Key	*DOWN key setted by parameter F6.19
	Run Key	*Used for running operation in the keyboard mode.
	Stop/Reset Key	*For stopping running in the running status; for resetting the operation in fault alarm status. *The function of the key is subject to F6.00
	Enter Key	*Enter into levels of menu screen, confirm settings.
	Quick multifunction key	*This key function is determined by the function code F6.21.
	Keyboard encoder	*In query status: functional items increasing and decreasing *In modify status: function feagues or editing increasing or decreasing *In monitoring status: setting frequency increasing or decreasing

## Installation

### Installation direction and Vacancy

PI500 series inverter according to different power rating, the requirements of around installation and reserved space is different, specifically as shown below:

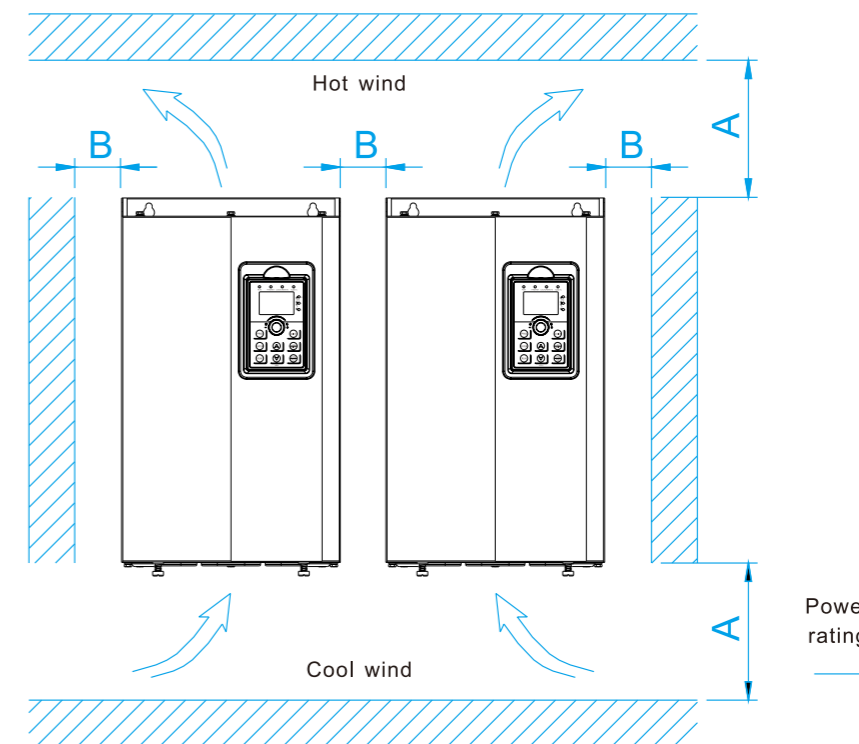

Mounted vertically upwards	Dimension requirement
0.75~11KW	A ≥ 100mm; B ≥ 10mm
15~22KW	A ≥ 200mm; B ≥ 10mm
30~75KW	A ≥ 200mm; B ≥ 50mm
93~400KW	A ≥ 300mm; B ≥ 50mm

Pi500 Series frequency inverter heat radiator circulated from bottom to top, when more than one inverter work together, usually mounted side by side. In the case of the need to install them by upper and lower rows, due to the heat of the lower inverters rising to the upper equipment, fault maybe caused, heat insulation deflector and other objects to be installed.

### Use of the environment

1. Environmental temperature -10°C to 50°C Above 40°C, the capacity will decrease 3% by each 1°C. So it is not advisable to use inverter above 50°C
2. Prevent electromagnetic interference, and away from interference sources.
3. Prevent the ingress of droplets, vapor, dust, dirt, lint and metal fine powder.
4. Prevent the ingress of oil, salt and corrosive gases.
5. Avoid vibration. Maximum amplitude is less than 5.9m/s (0.6g).
6. Avoid high temperature and humidity or exposure to rain, humidity shall be less than 90% RH (non-condensing). In the presence of corrosive gas, maximum relative humidity is no more than 60%.
7. Altitude below 1000 meters.
8. Never use in the dangerous environment of flammable, combustible, explosive gas, liquid or solid.

### Wiring

Frequency inverter wiring is divided by main circuit and control circuit. Users must properly connect frequency inverter in accordance with the wiring connection diagram showing below.

# Wiring diagram

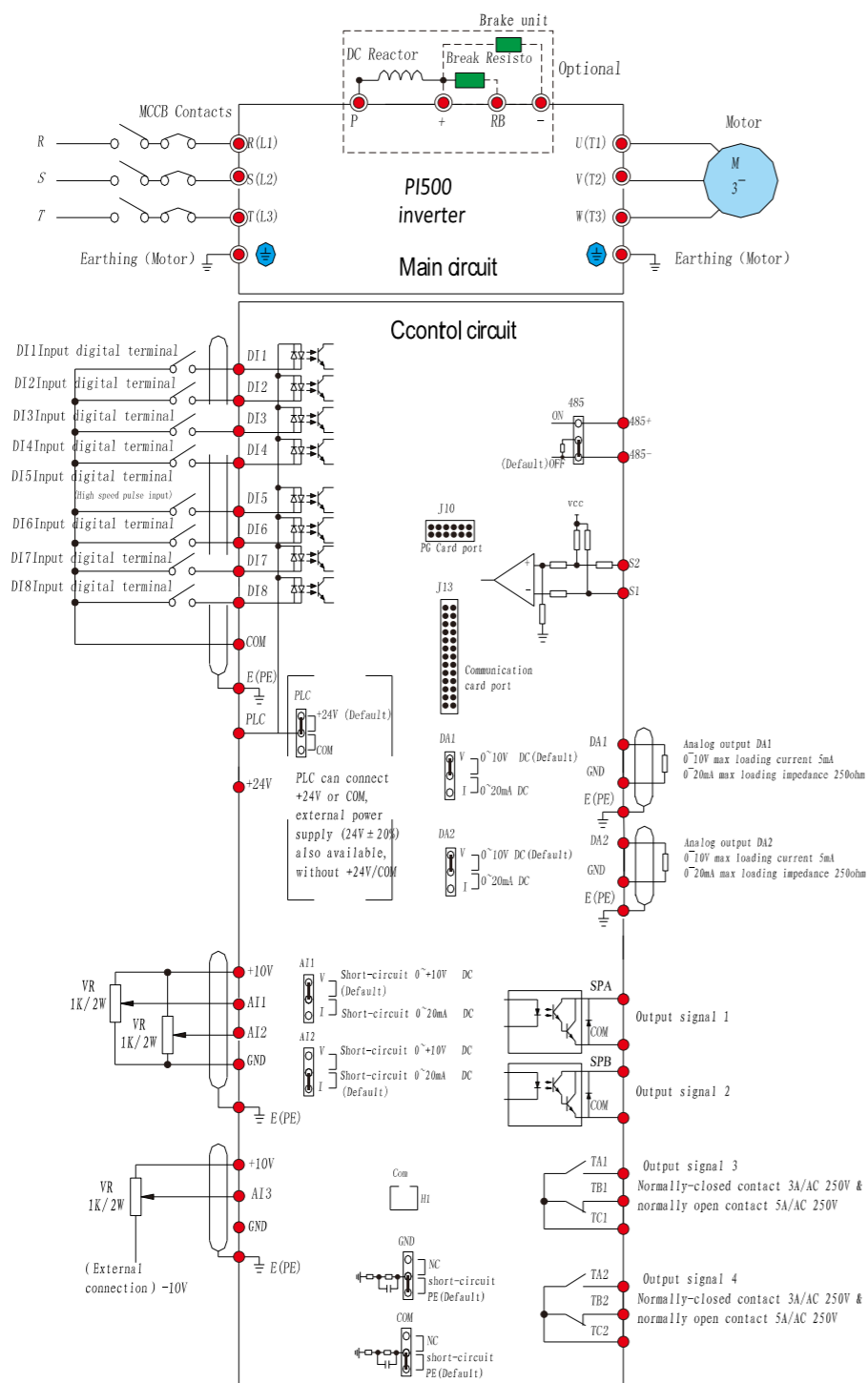

# Peripheral equipment

Purpose	Name	Specification
Protect frequency inverter wiring	Wiring breaker or leakage protector	To protect frequency inverter connection, please set wiring breaker or leakage protector by the side of power supply. Please use preventing ultra-harmonics leakage protector.
Prevent braking resistor burning-out	AC contactor	To prevent braking resistor burning-out when connecting, please set AC contactor, meanwhile, please connect surge absorber on the coil.
Preventing switching surge leaking out	Surge absorber	Surge absorber absorbing electromagnetic contactor and control relay switching surge, please install surge absorber on the electromagnetic contactor and control relay of frequency inverter.
Insulation input/output signal	Isolator	Due to frequency inverter insulation input/output signal, isolator can reduce inductive interference effectively
Improve frequency inverter input power factor	DC reactor/AC reactor	Apply to improve frequency inverter input power factor, please set DC reactor or AC reactor, when using large capacity power supply (above 600kW)
Reduce noise disturbance	Input noise filter	Input wiring can reduce noise flow into frequency inverter input power supply system. Please install the filter close to frequency inverter.
	Output noise filter	From frequency inverter output wiring reduce noise, please install the filter close to frequency inverter.
Machine stop running on setting time	Braking resistor	Braking unit will consume machine regenerated energy, which will reduce decrease time
	Braking unit	Braking unit and braking resistor combined using on machine, this will reduce motor decrease time.
Control frequency inverter operation from outside	Operator (small plastic-made device)	Control frequency setting and operation/stop operation by analog quantity instructions from distance.
	Operator (standard nickel clad made)	Control frequency setting and operation/stop operation by analog quantity instructions from distance.
Ensure frequency inverter sudden power failure compensation	Sudden power failure/compensate unit	To control power supply sudden failure compensation.
Setting and monitoring frequency and voltage from outside	Frequency meter	Outside setting and monitoring frequency device.
	Frequency setting device	
	Output voltmeter	Outside setting output volt device is PWM frequency inverter specialized voltmeter.
Adjust frequency instruction input and frequency meter, ampere meter full scale	Frequency instruction using thyrector baseboard	Install and control circuit terminal, input frequency instruction.
	Frequency meter full scale adjust resistor	Adjust frequency meter and ampere meter full scale.

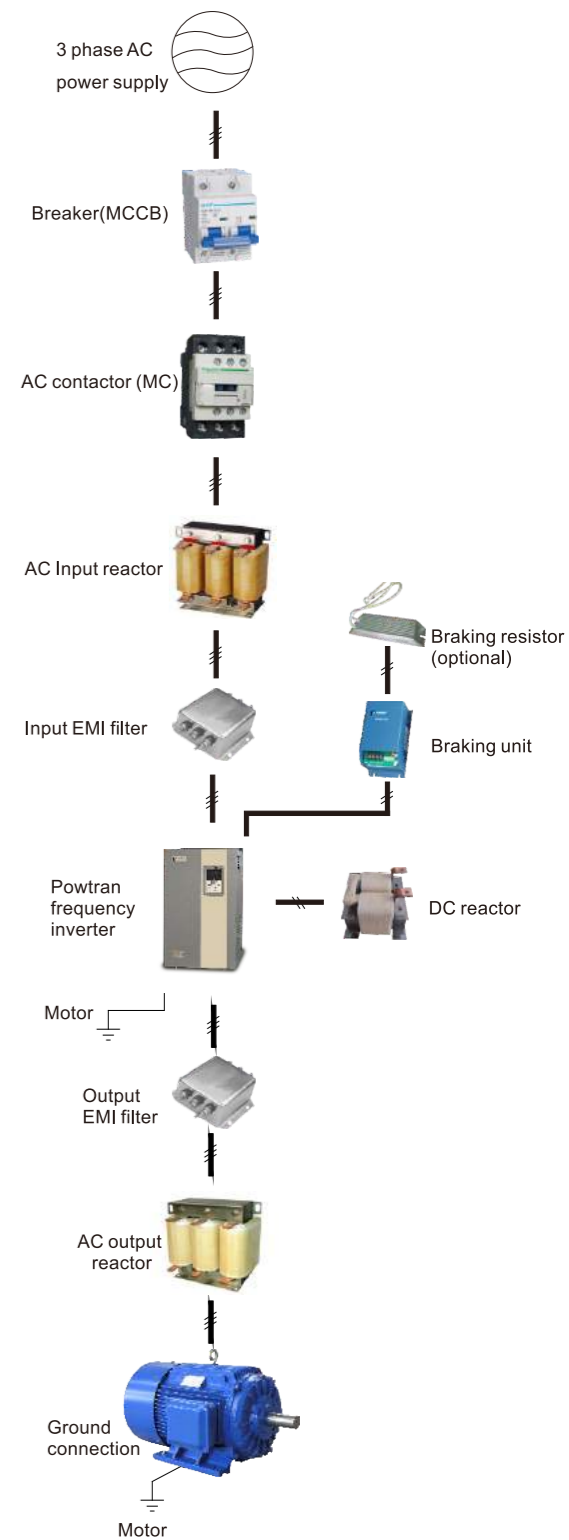

## Some application cases



### Coal Mining Industry

- engine analyzer,slag pot carrier, feeding machine iron ladle motor, fireproof door motor ore washing pump, suction fan in the pit, air supply system, hauling machine



### Fan Industry

- centrifugal compressor, axial-flow compressor centrifugal blower, roots blower centrifugal fan, axial flow fan enke blower

### Machine Tool Industry

- ncelectro-spindle,vertical lathe spindle,surface grinder spindle,boring machine spindle, sawing machine



### Injection Molding Machine

- extruding machine,injection machine, dise refiner,internal mixer,granulate machine

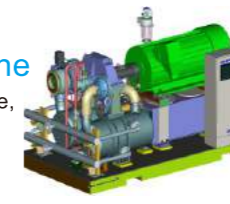

### Hoisting Industry

- mine hoist,mining electric locomotive port hoist,builders' lift,pile driver,large crane motor,tower crane lifting



### Petroleum Industry

- plunger pump, beam pumping unit, oil transfer pump,gas transmission pipeline system compressor,



### Chemical Industry

- vacuum kneader(agitator),dryer film blowing machine,plastic mill,pulverizer drafting device for short fiber,high speed spinning machine for chemical fiber feedstock pump for oil refinery, pump for coking unit



### Iron And Steel Industry

- winding engine for iron-smelting blast furnace, dust removing blower for blast furnace, air blower for blast furnace gas blanketing blowing engine,roots blower for digital thermometer,variable frequency exhaust fan for steel furnace roasting and purifing fan,hot rolling machine,cold tandem rolling mill, feeding system,mill exhauster,vibrating sieving machine, wire drawing machine,winding machine,blender mixer,drying machine,slime pump, draining pump,water supply pump,unbender,pipemaking machine, ladle crane motor



### Power Industry

- boiler blower,induced draft fan,boiler feeding pump,circulating water pump,low pressure drain pump,condensate pump,cooling water pump,mortar pump,coal feeder.



### Textile Industry

- spinning machine,fagoting machine,pounding machine, knitting machine,centrifugal dehydrator,spinning frame, aeration machine for print works,tentering and thermo-fixing machine,high temperature dyeing machine,decorating machine,bleaching machine, dyeing jiggers

### Photovoltaic

- microwave relay station,optical cable communication system, wireless paging station,satellite communication and satellite television receiving system. computerized telephone system in countryside,communication system in troops,railway and highway signalling system, lighthouse and beacon light, meteorological station,seismic station



### Compressor

- piston compressor, screw compressor,centrifugal compressor,linear compressor



### Pump

- petroleum pump,metallurgical pump, chemical pump,fishing pump,mining pump,power pump,water conservancy pump,sewage pump,food pump, brewing pump,pharmacy pump, beverage pump,fuel pump,condiment pump,paper pump,textile pump,printing and dyeing pump,ceramic pump, paint conveyer pump,agricultural chemical pump,fertilizer pump,sugar-syrup pump, methanol pump,spary pump,salt pump, beer pump,starch pump,feed pump



### Winding Machine

- lithium battery winding machine, capacitor core winding machine, textile winding machine



### Conveyor Belt

- belt-type conveyer,plate conveyer, car type conveyer,escalator,passenger conveyer,scraper conveyer,embedded scraper conveyer,bucket conveyer, bucket elevator,underslung conveyer, underslung conveyer



### Heating System

- constant pressure water supply system for boiler,mill exhauster, belt conveyer for coal,coal breaker,air blower,induced draft fan,cold-rolling mill

