

# AF40 ... AF65 3-polige Schütze

Abmessungen in mm, Zoll

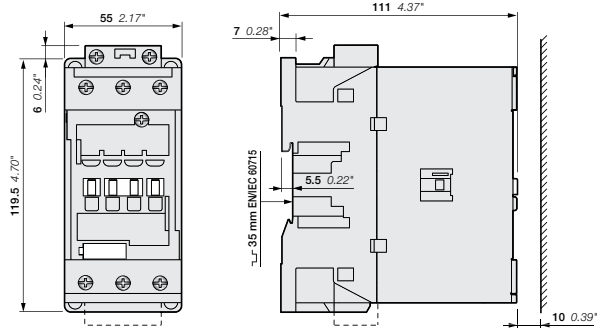

5 AF40, AF52, AF65

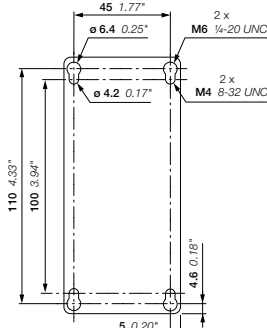

AF40, AF52, AF65

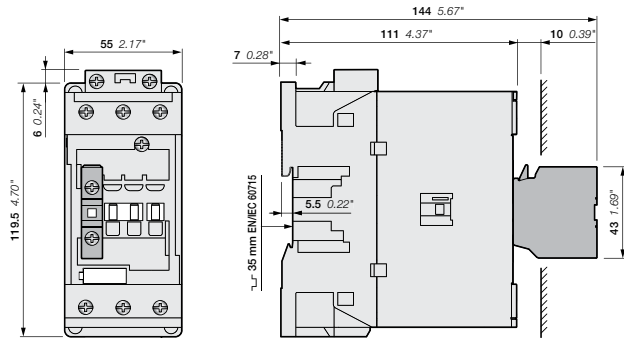

AF40, AF52, AF65  
+ CA4, CC4 1-poliger Hilfskontaktblock

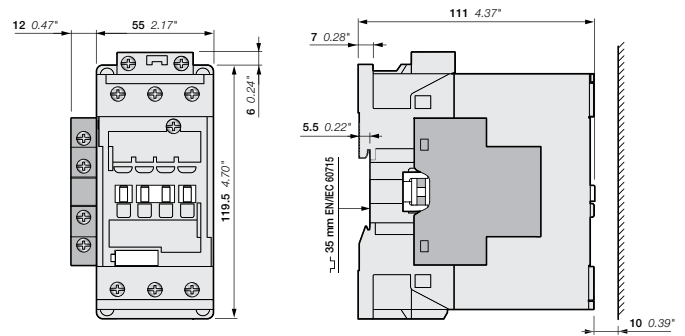

AF40, AF52, AF65-30-00 + CAL4-11 2-poliger Hilfskontaktblock  
AF40, AF52, AF65-30-11

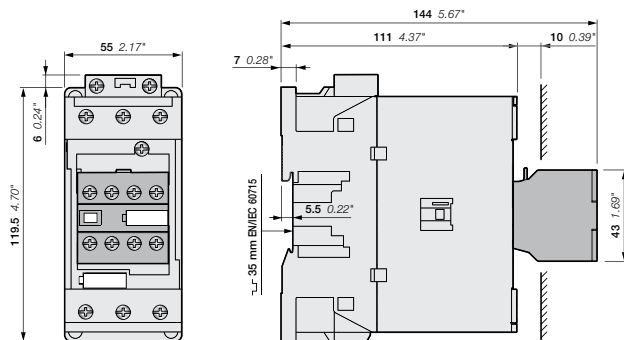

AF40, AF52, AF65  
+ CA4 4-poliger Hilfskontaktblock

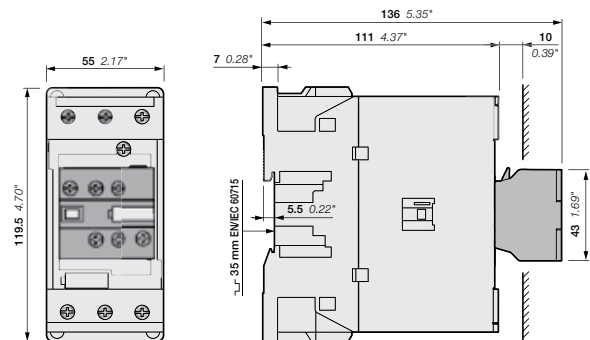

AF40, AF52, AF65  
+ CAT4 2-poliger Hilfskontaktblock und Spulenanschlussklemmenblock

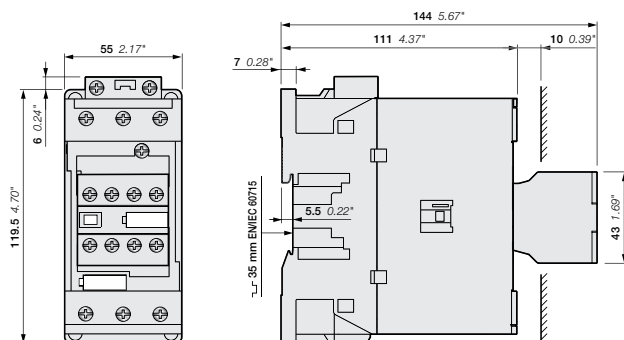

AF40, AF52, AF65...-30-22

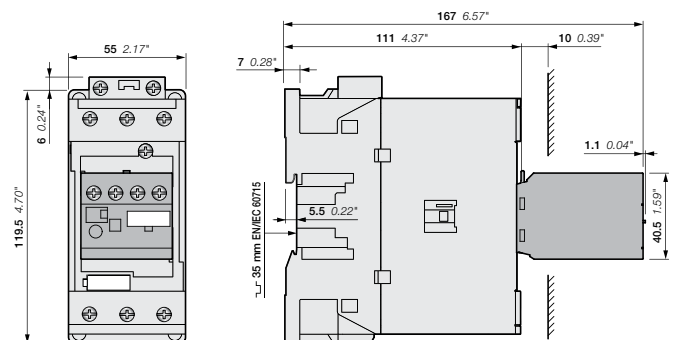

AF40, AF52, AF65  
+ TEF4 elektronisches Zeitrelais

# AF40 ... AF65 3-polige Schütze

## Abmessungen in mm, Zoll

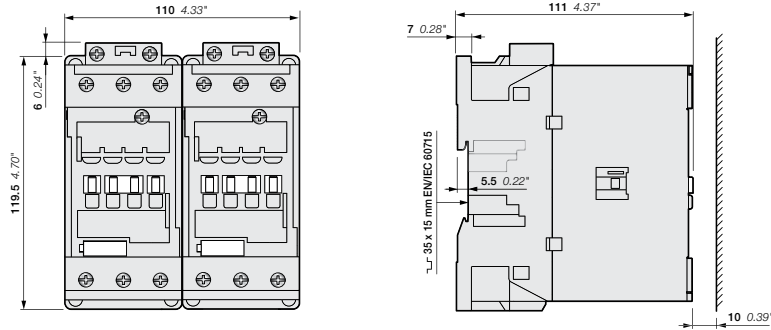

AF40, AF52, AF65  
+ VM96-4 mechanischer Verriegelungssatz

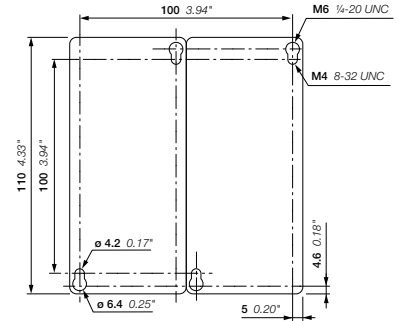

AF40, AF52, AF65  
+ VM96-4 mechanischer Verriegelungssatz

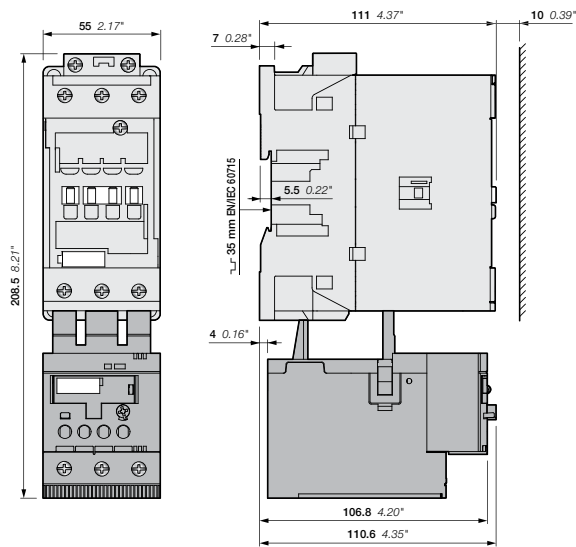

AF40, AF52, AF65  
+ TF65 thermisches Überlastrelais

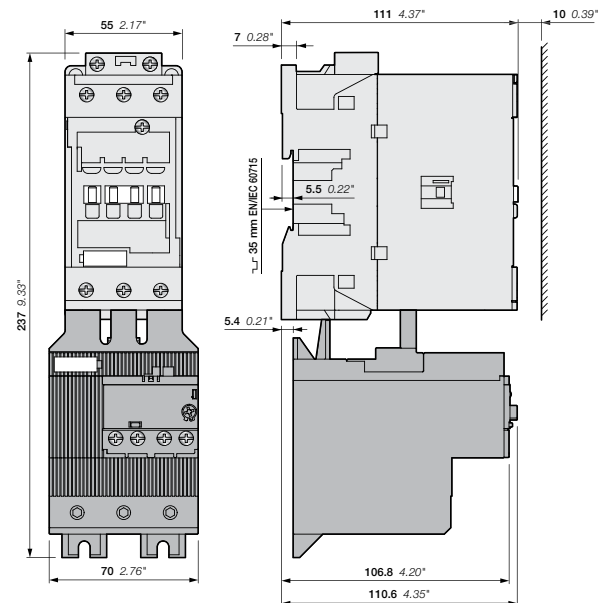

AF40, AF52, AF65  
+ EF65 elektronisches Überlastrelais

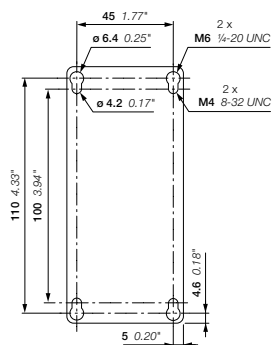

AF40, AF52, AF65  
+ TF65, EF65

# AF80 ... AF96 3-polige Schütze

Abmessungen in mm, Zoll

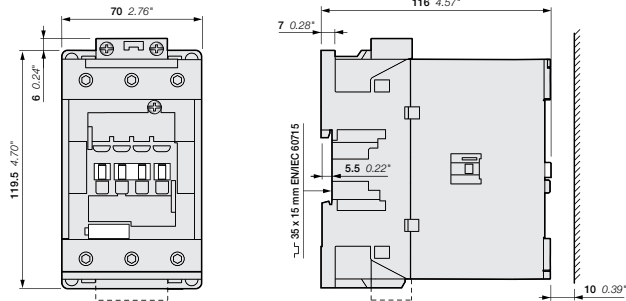

AF80, AF96

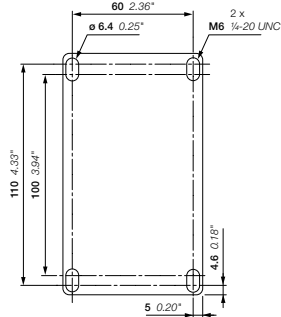

AF80, AF96

5

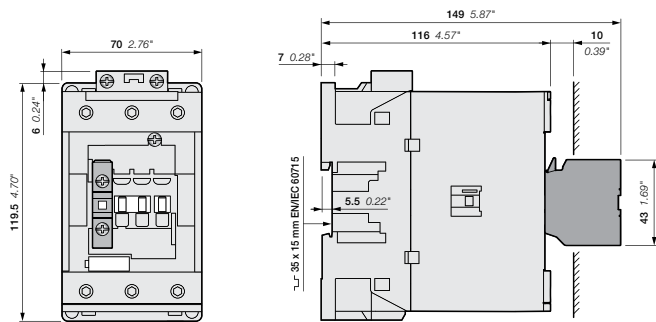

AF80, AF96  
+ CA4, CC4 1-poliger Hilfskontaktblock

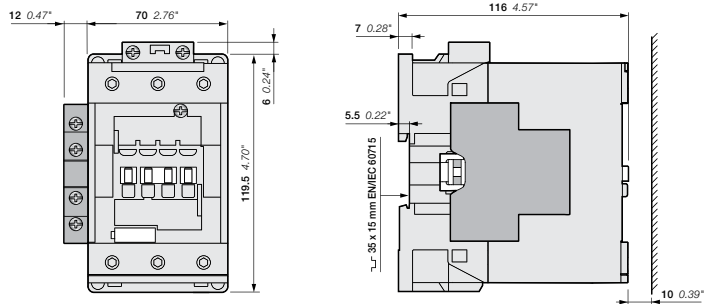

AF80, AF96-30-00 + CAL4-11 2-poliger Hilfskontaktblock  
AF80, AF96-30-11

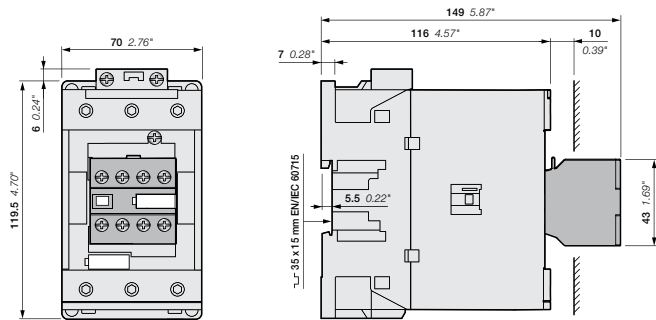

AF80, AF96  
+ CA4 4-poliger Hilfskontaktblock

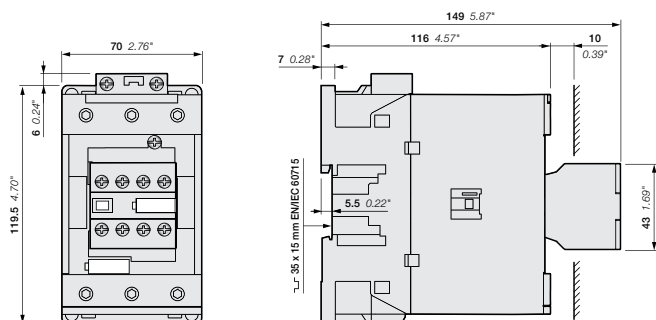

AF80, AF96...-30-22

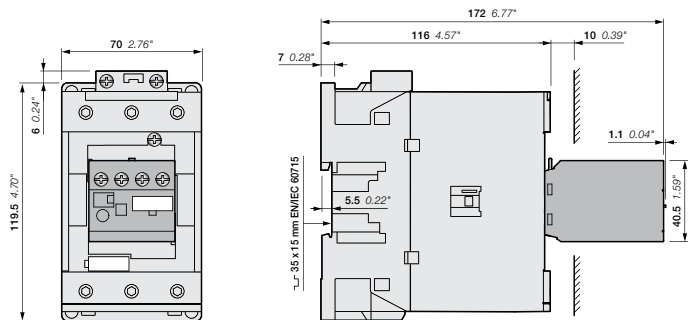

AF80, AF96  
+ TEF4 elektronisches Zeitrelais

# AF80 ... AF96 3-polige Schütze

## Abmessungen in mm, Zoll

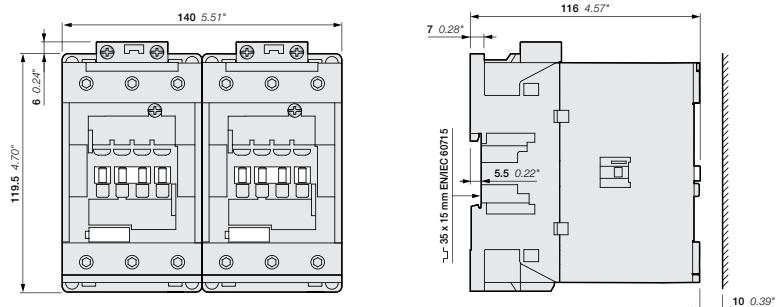

AF80, AF96  
+ VM96-4 mechanischer Verriegelungssatz

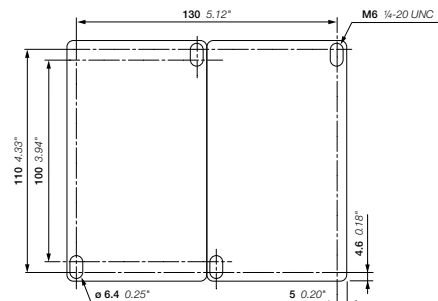

AF80, AF96  
+ VM96-4 mechanischer Verriegelungssatz

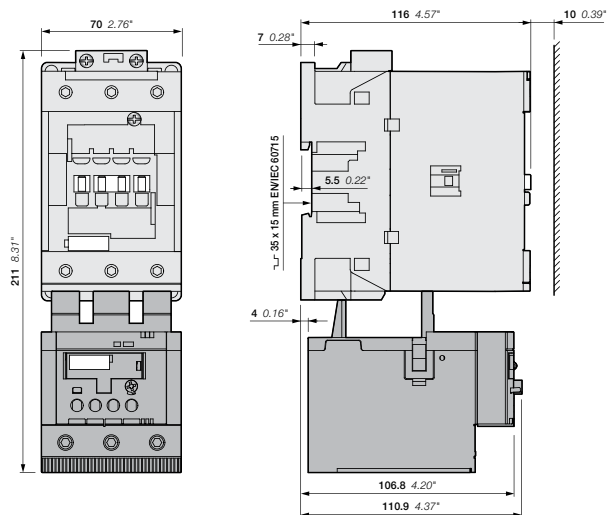

AF80, AF96  
+ TF96 thermisches Überlastrelais

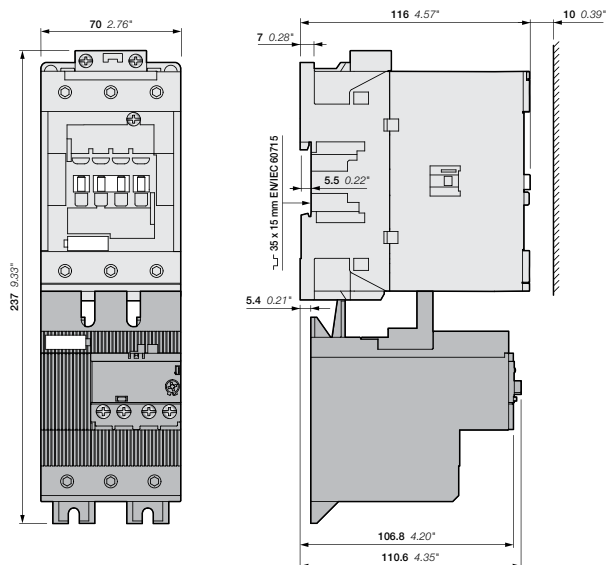

AF80, AF96  
+ EF96 elektronisches Überlastrelais

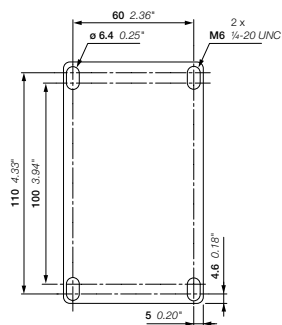

AF80, AF96  
+ TF96, EF96